

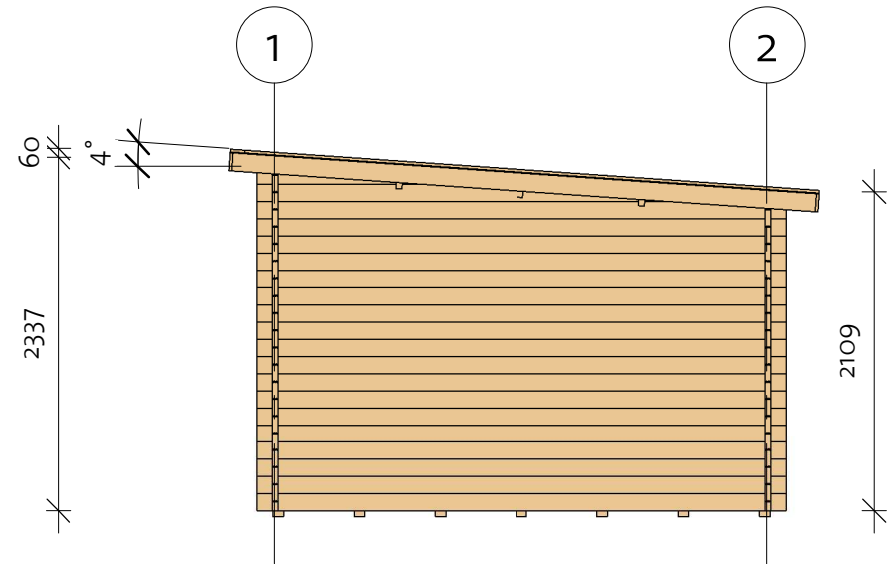

# Jody 40 (450x330)

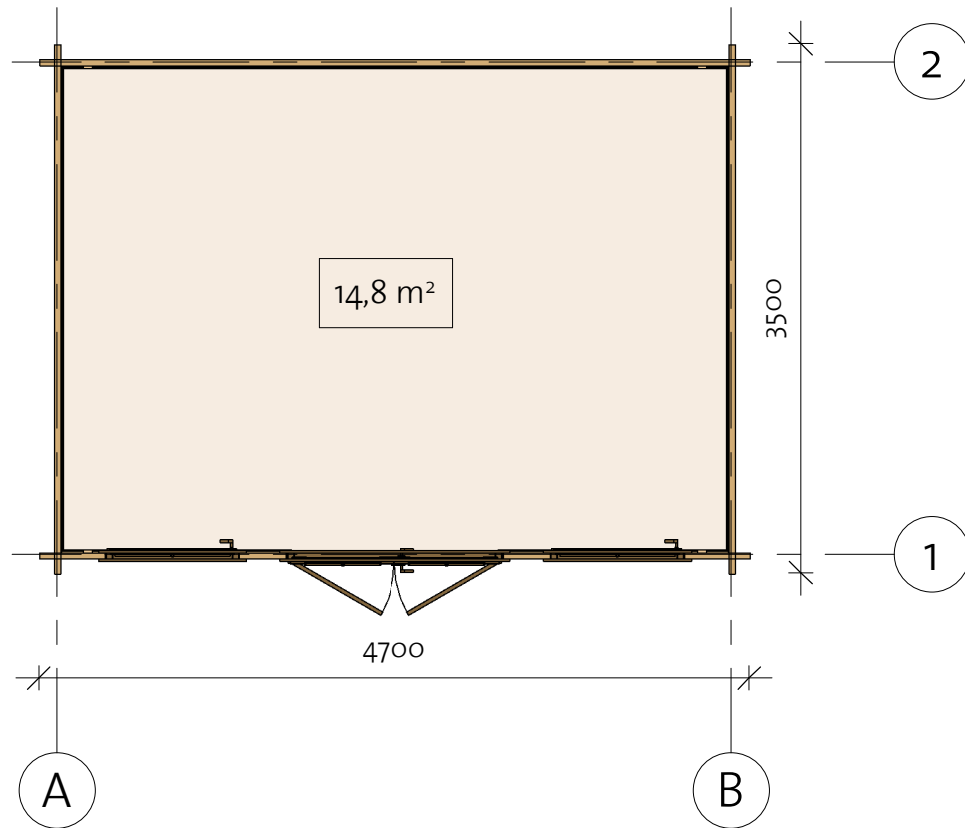
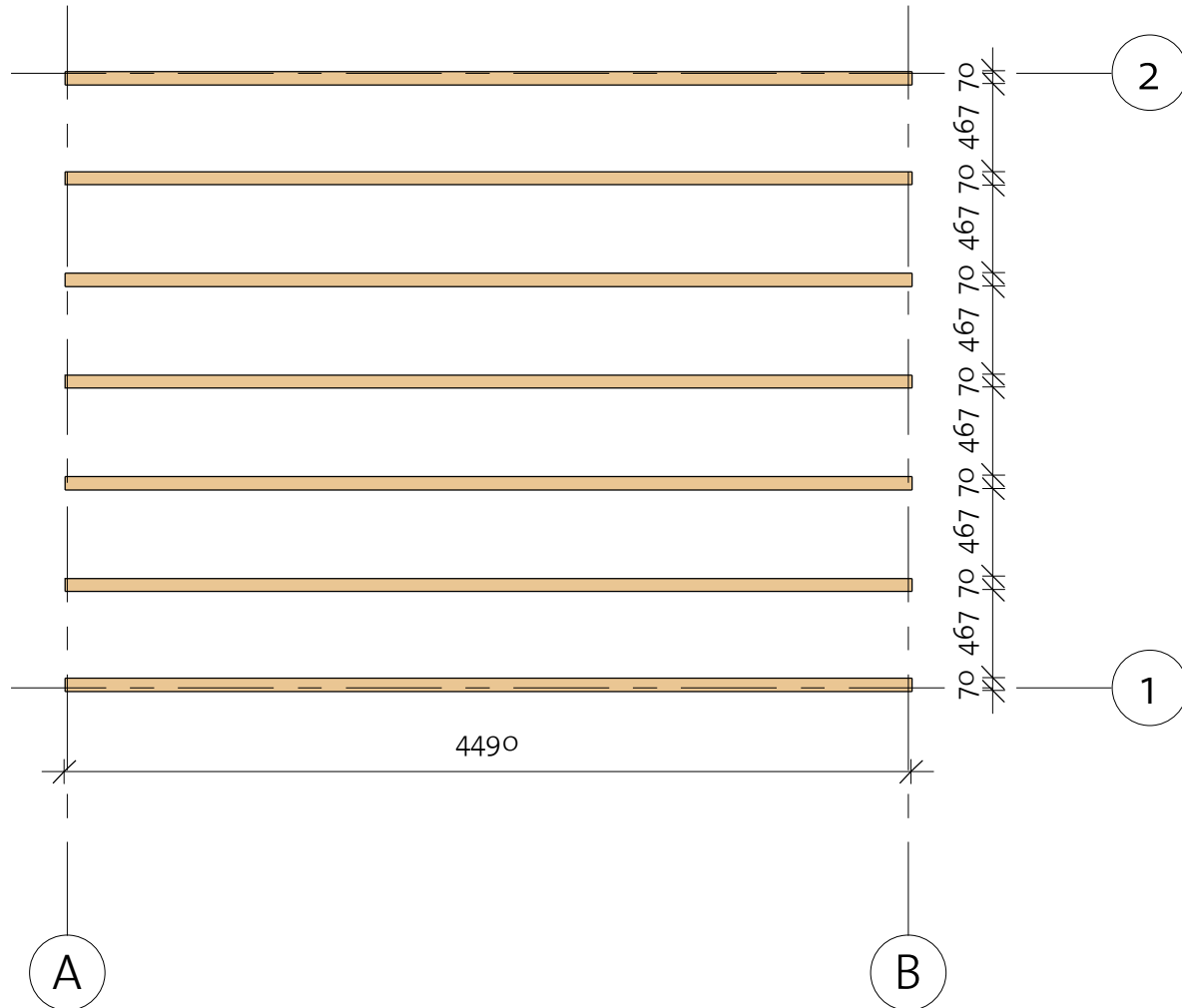

# Jody 40 (450x330)

Foundation



| Impregnated foundation beams |              |   |       |        |
|------------------------------|--------------|---|-------|--------|
| Mark                         | Type         | Profile   | Count | Length |
| IFB                          | IFB<br>70x40 |  | 7     | 4490   |

# Jody 40 (450x330)

Floor Plan

① Baseboard

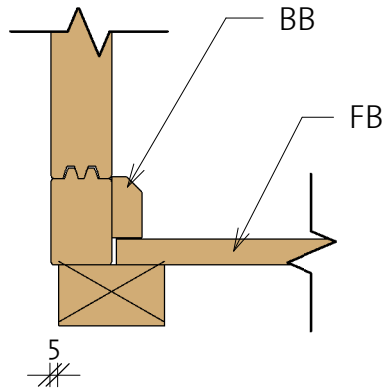

| Floor Schedule |      |         |       |        |
|----------------|------|---------|-------|--------|
| Mark           | Type | Profile | Count | Length |

|    |           |   |    |      |
|----|-----------|---|----|------|
| FB | FB 17x114 |  | 40 | 3214 |
|----|-----------|---|----|------|

|     |          |   |   |      |
|-----|----------|---|---|------|
| BB1 | BB 20x40 |  | 2 | 4500 |
| BB2 | BB 20x40 |   | 2 | 3300 |

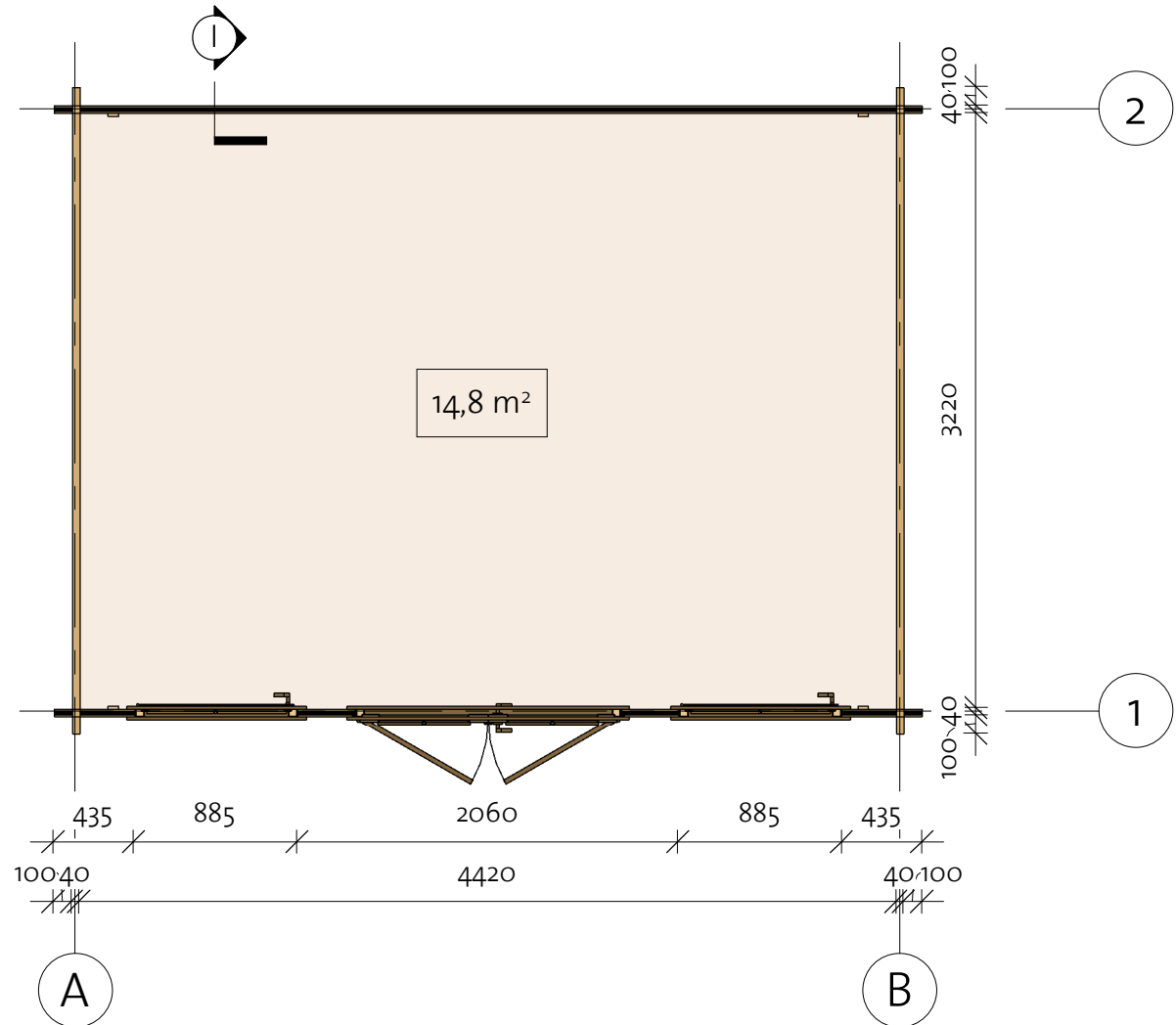

# Jody 40 (450x330)

Wall 1

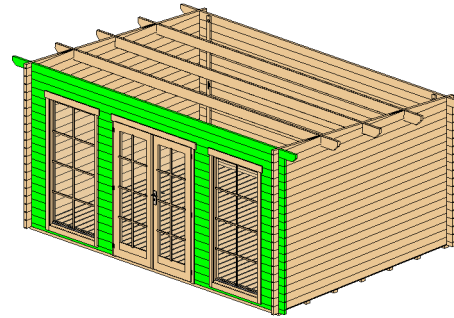

| Wall 1 |         |       |            |
|--------|---------|-------|------------|
| Mark   | Profile | Count | Cut Length |

|       |        |    |      |
|-------|--------|----|------|
| 1BL-1 | 40x57  | 2  | 1630 |
| 1LG-1 | 40x114 | 34 | 310  |
| 1LG-2 | 40x114 | 34 | 435  |
| 1LG-3 | 40x114 | 2  | 4700 |
| 1TL-1 | 40x114 | 1  | 5100 |

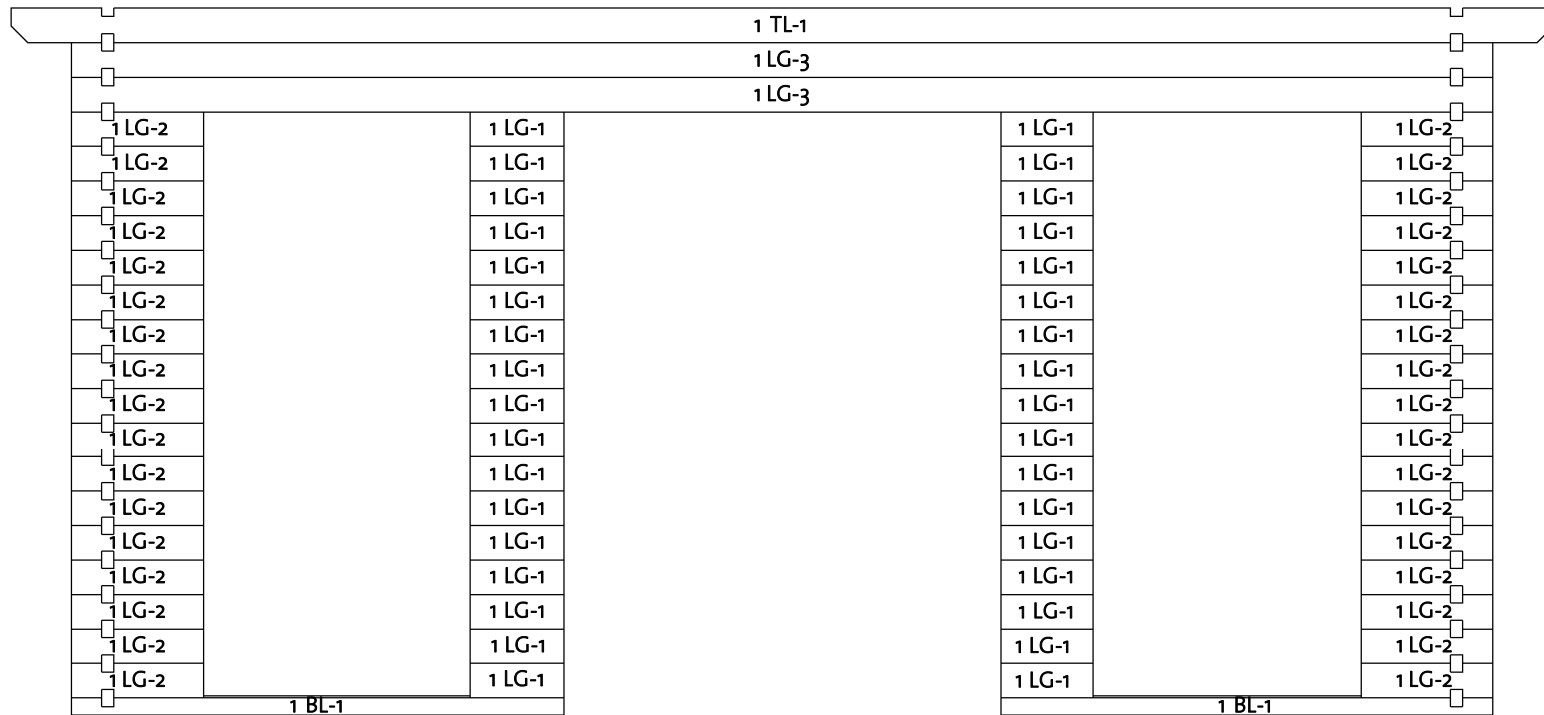

| Log Profile Wall 1 |         |
|--------------------|---------|
| Profile            | Profile |

|        |  |
|--------|--|
| 40x57  |  |
| 40x114 |  |
| 40x114 |  |

# Jody 40 (450x330)

Wall 2

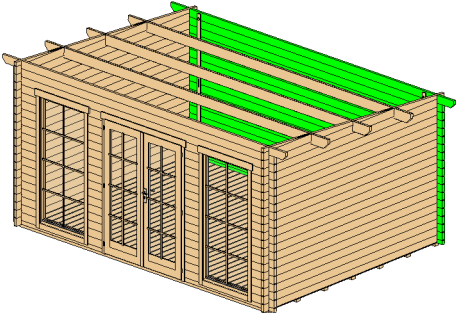

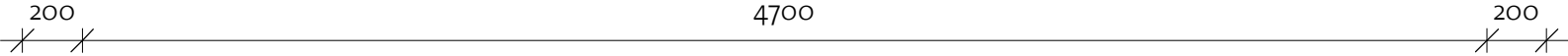
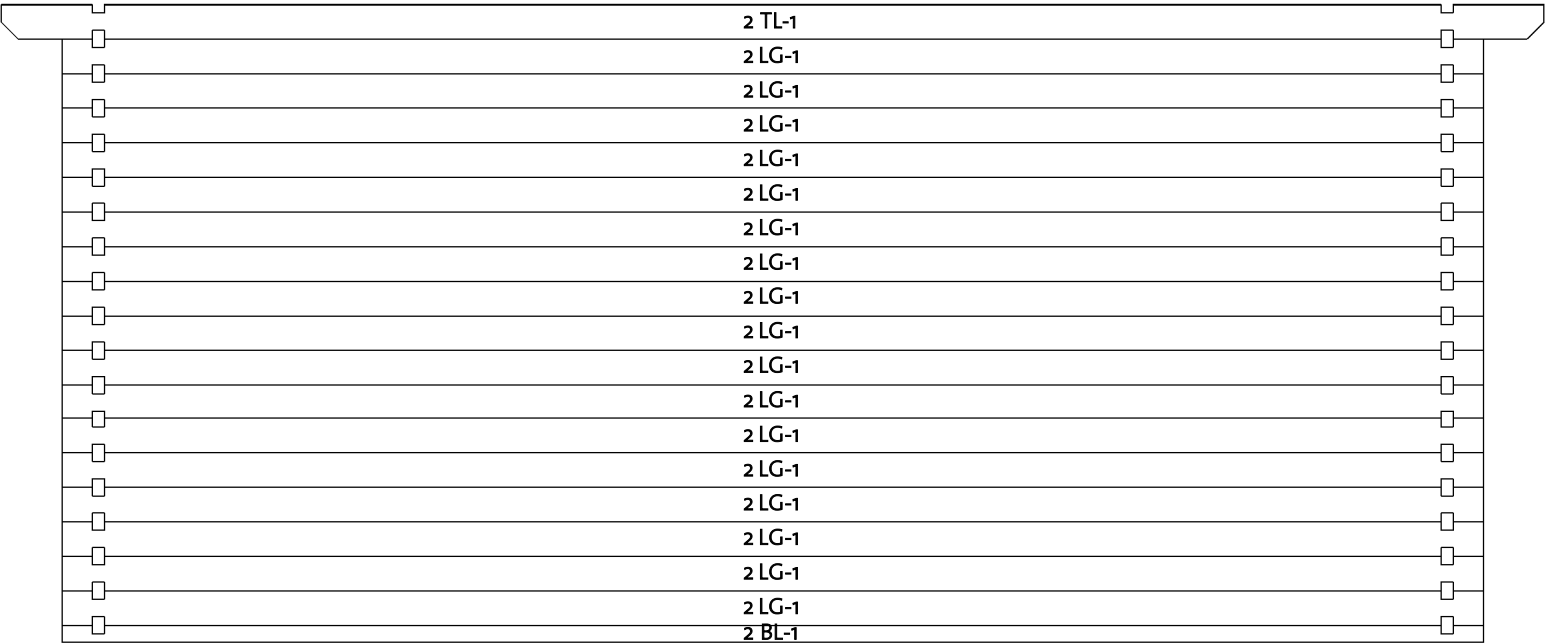

| Wall 2 |         |       |            |
|--------|---------|-------|------------|
| Mark   | Profile | Count | Cut Length |

|       |        |    |      |
|-------|--------|----|------|
| 2BL-1 | 40X57  | 1  | 4700 |
| 2LG-1 | 40X114 | 17 | 4700 |
| 2TL-1 | 40X114 | 1  | 5100 |



| Log Profile Wall 2 |         |
|--------------------|---------|
| Profile            | Profile |

|        |   |
|--------|---|
| 40X57  |   |
| 40X114 |  |
| 40X114 |  |

# Jody 40 (450x330)

Wall A

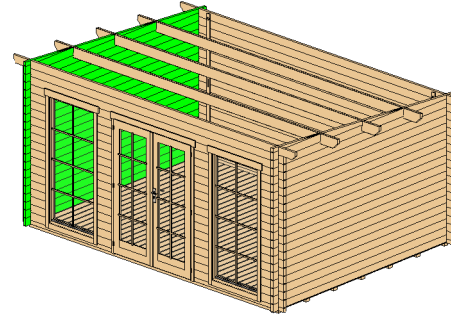

| Wall A |         |       |            |
|--------|---------|-------|------------|
| Mark   | Profile | Count | Cut Length |

|        |        |    |      |
|--------|--------|----|------|
| ALG-1* | 40x114 | 1  | 915  |
| ALG-2* | 40x114 | 1  | 2536 |
| ALG-3  | 40x114 | 18 | 3500 |
| ALG-4* | 40x114 | 1  | 3500 |

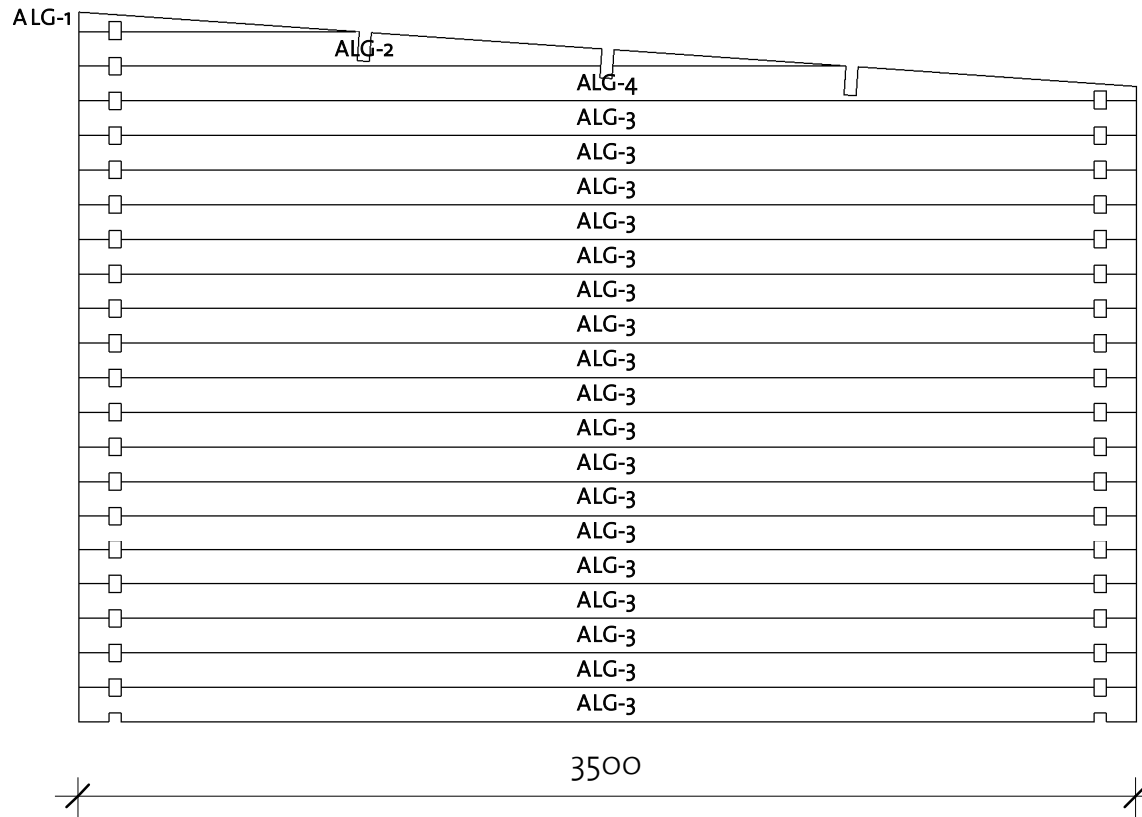

\* Gable - delivered premounted

| Log Profile Wall A |         |
|--------------------|---------|
| Profile            | Profile |

|        |  |
|--------|--|
| 40x114 |  |
|--------|--|

# Jody 40 (450x330)

Wall B

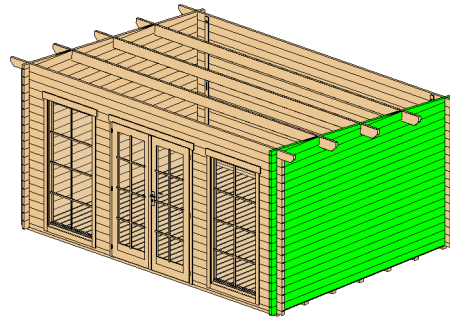

| Wall B |         |       |            |
|--------|---------|-------|------------|
| Mark   | Profile | Count | Cut Length |

|        |        |    |      |
|--------|--------|----|------|
| BLG-1* | 40X114 | 1  | 915  |
| BLG-2* | 40X114 | 1  | 2536 |
| BLG-3  | 40X114 | 18 | 3500 |
| BLG-4* | 40X114 | 1  | 3500 |

\* Gable - delivered premounted

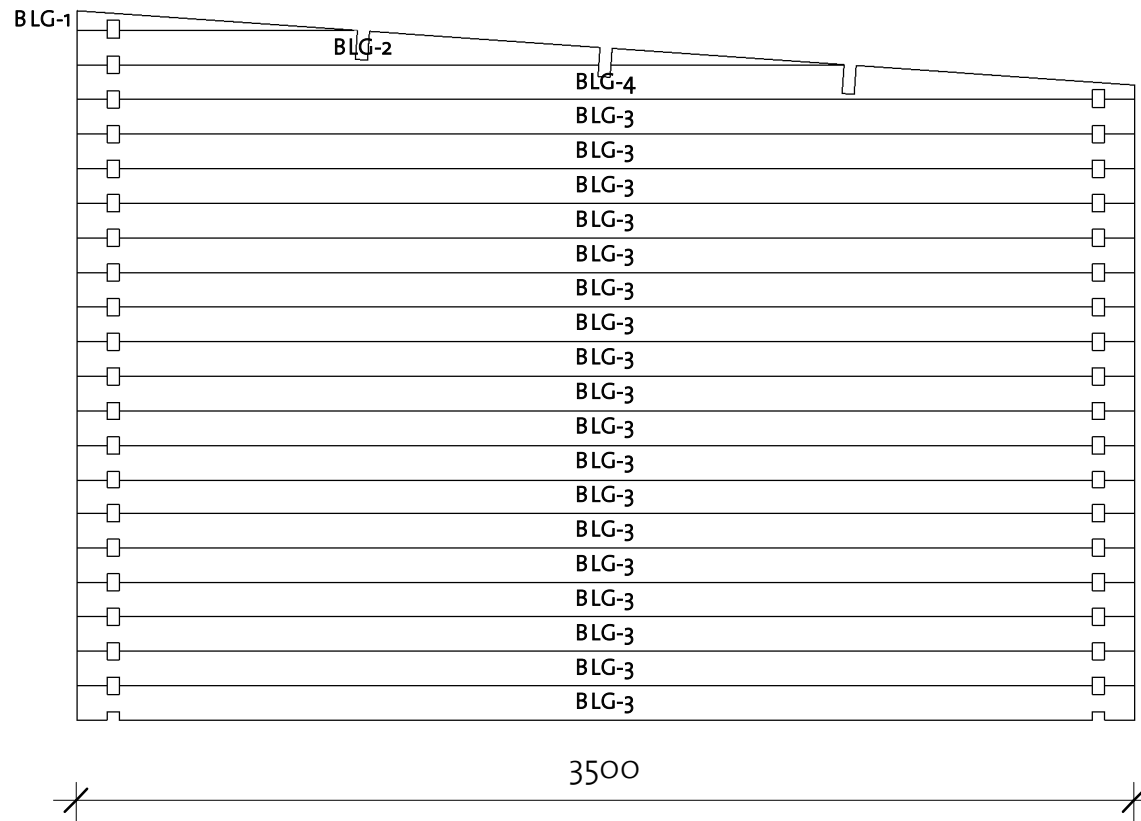

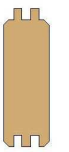

| Log Profile Wall B |         |
|--------------------|---------|
| Profile            | Profile |

|        |   |
|--------|---|
| 40X114 |  |
|--------|---|

# Jody 40 (450x330)

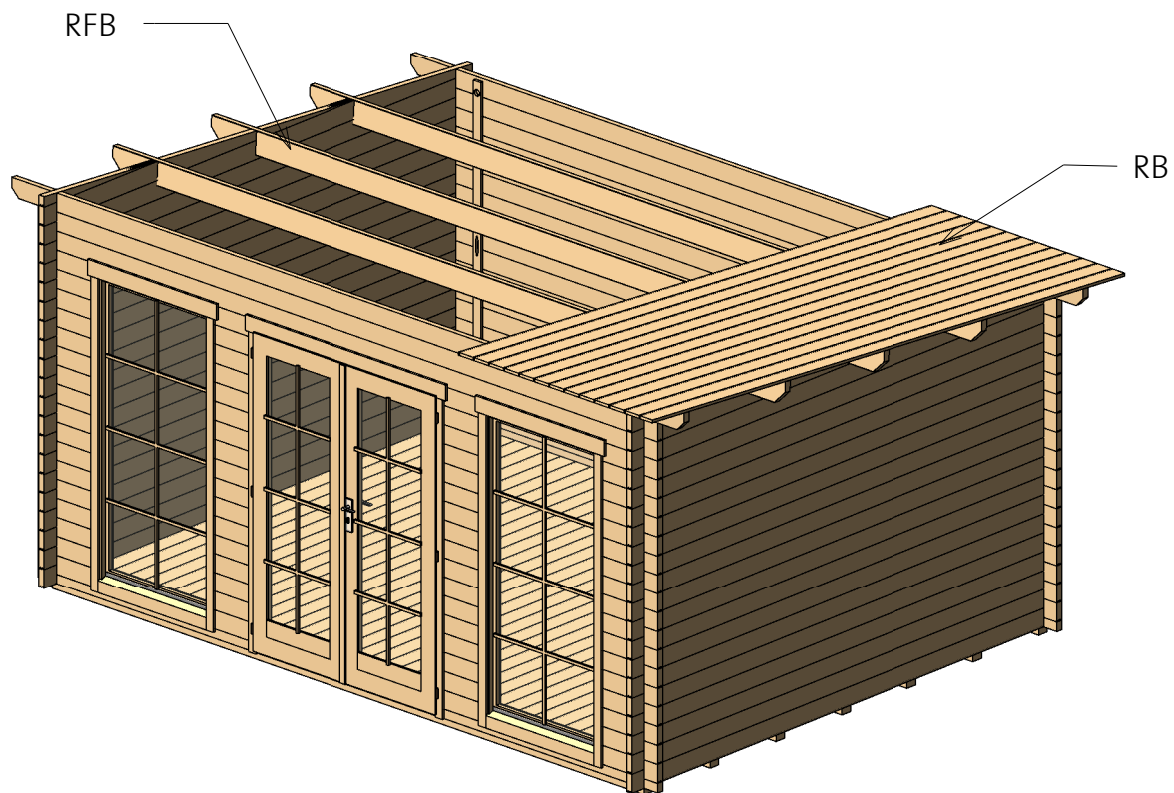
Roof 1



| Roof |                |   |       |        |
|------|----------------|---|-------|--------|
| Mark | Type           | Profile   | Count | Length |
| RFB  | Beam<br>40x143 |  | 3     | 5100   |
| RB   | 17x114         |  | 46    | 3868   |



# Jody 40 (450x330)

Roof 2

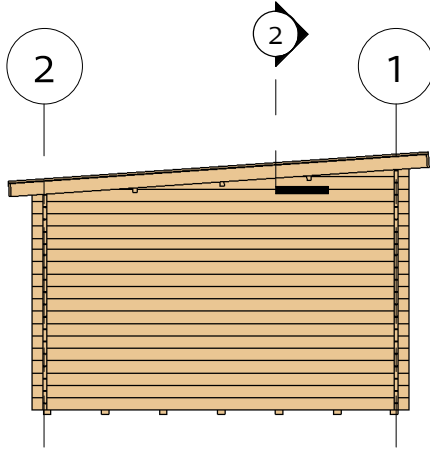

② Facia

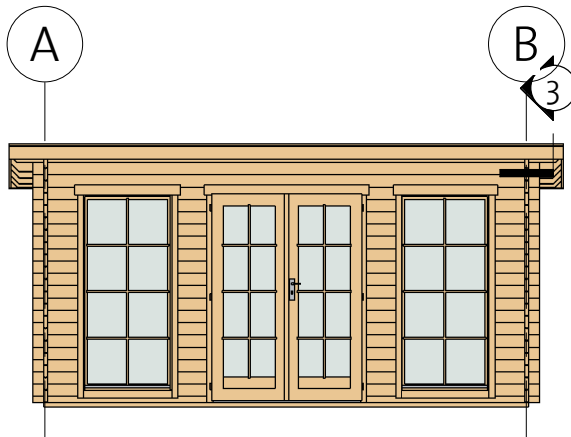
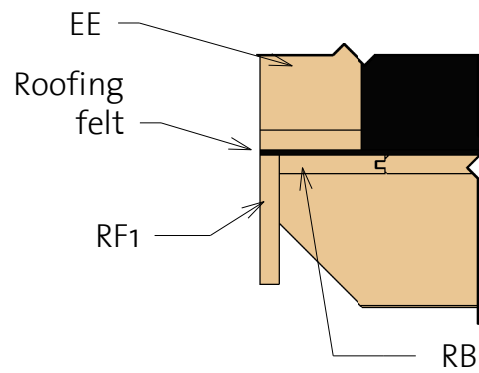

③ Roof Reinforcement

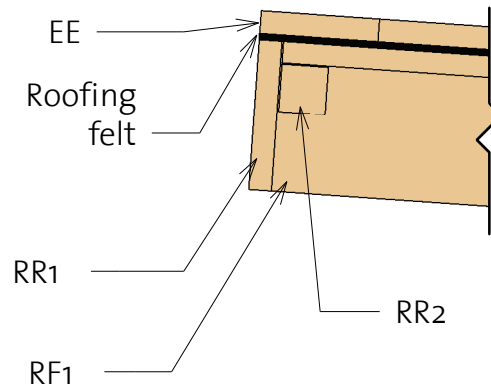

| Fascia Schedule |      |         |       |        |
|-----------------|------|---------|-------|--------|
| Mark            | Type | Profile | Count | Length |

|     |                                 |  |   |      |
|-----|---------------------------------|--|---|------|
| EE1 | Eave Edging<br>18x95            |  | 2 | 3810 |
| EE2 | Eave Edging<br>18x95            |  | 1 | 5140 |
| RF1 | Roof Fascia<br>18x120           |  | 2 | 3869 |
| RR1 | Roof<br>reinforcement<br>18x120 |  | 2 | 5140 |
| RR2 | Roof<br>reinforcement<br>38x38  |  | 2 | 5100 |

# Jody 40 (450x330)

Extras

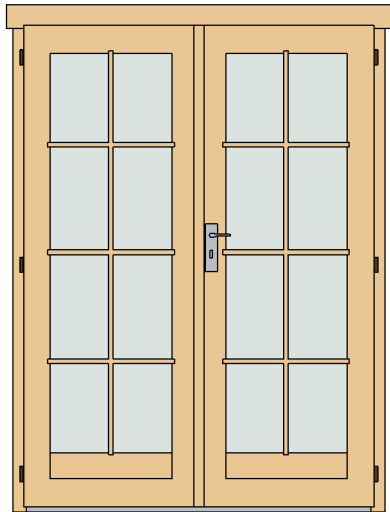

| Door Schedule |                             |       |        |       |
|---------------|-----------------------------|-------|--------|-------|
| Mark          | Type                        | Width | Height | Count |
| CDD3R         | Classic double door 3 right | 1425  | 1955   | 1     |
| DCB8          | Door Crossbar 8             | --    | --     | 2     |

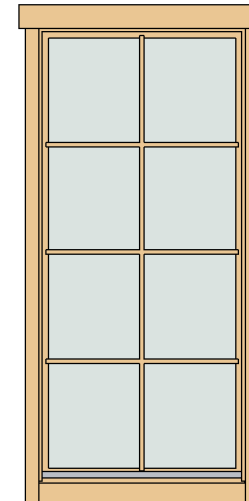

| Window Schedule |                         |       |        |       |
|-----------------|-------------------------|-------|--------|-------|
| Mark            | Type                    | Width | Height | Count |
| CW4R            | Classic window 4, right | 875   | 1890   | 2     |
| WCB8            | Windows Crossbar 8      | --    | --     | 2     |

- \* Windows intended for tilt opening only!
- \* Fenster zur Eröffnung nur zum Kippen vorgesehen!
- \* Aknad on ette nähtud ainult kaldu avamiseks!

| Fasteners/Extras |      |       |
|------------------|------|-------|
| Name             | Type | Count |

|          |            |     |
|----------|------------|-----|
| Hitblock | 300-400 mm |     |
| Bolts    | M8 x 70    | 12  |
| Screws   | 5,0 x 70   | 16  |
| Screws   | 6,0 x 140  | 45  |
| Nails    | 1,4 x 40   | 45  |
| Screws   | 4,0 x 40   | 670 |

| Type | Count | Length |
|------|-------|--------|
|------|-------|--------|

|                 |   |      |
|-----------------|---|------|
| Windboard 18x40 | 4 | 2200 |
|-----------------|---|------|





# Jody 40 (450x330)

## List of all items 1



### Impregnated foundation beams

| Mark | Type         | Profile   | Count | Length |
|------|--------------|---|-------|--------|
| IFB  | IFB<br>70x40 |  | 7     | 4490   |





### Floor Schedule

| Mark | Type        | Profile   | Count | Length |
|------|-------------|---|-------|--------|
| FB   | FB 17x114   |  | 40    | 3214   |
| BB1  | BB<br>20x40 |  | 2     | 4500   |
| BB2  | BB<br>20x40 |   | 2     | 3300   |

### Roof

| Mark | Type           | Profile   | Count | Length |
|------|----------------|---|-------|--------|
| RFB  | Beam<br>40x143 |  | 3     | 5100   |
| RB   | 17x114         |  | 46    | 3868   |

### Fascia Schedule

| Mark | Type                            | Profile   | Count | Length |
|------|---------------------------------|---|-------|--------|
| EE1  | Eave Edging<br>18x95            |  | 2     | 3810   |
| EE2  | Eave Edging<br>18x95            |  | 1     | 5140   |
| RF1  | Roof Fascia<br>18x120           |  | 2     | 3869   |
| RR1  | Roof<br>reinforcement<br>18x120 |  | 2     | 5140   |
| RR2  | Roof<br>reinforcement<br>38x38  |  | 2     | 5100   |

# Jody 40 (450x330)

## List of all items 2

### Wall 1

| Mark | Profile | Count | Cut Length |
|------|---------|-------|------------|
|------|---------|-------|------------|

|       |        |    |      |
|-------|--------|----|------|
| 1BL-1 | 40x57  | 2  | 1630 |
| 1LG-1 | 40x114 | 34 | 310  |
| 1LG-2 | 40x114 | 34 | 435  |
| 1LG-3 | 40x114 | 2  | 4700 |
| 1TL-1 | 40x114 | 1  | 5100 |

### Wall A

| Mark | Profile | Count | Cut Length |
|------|---------|-------|------------|
|------|---------|-------|------------|

|        |        |    |      |
|--------|--------|----|------|
| ALG-1* | 40x114 | 1  | 915  |
| ALG-2* | 40x114 | 1  | 2536 |
| ALG-3  | 40x114 | 18 | 3500 |
| ALG-4* | 40x114 | 1  | 3500 |

### Wall 2

| Mark | Profile | Count | Cut Length |
|------|---------|-------|------------|
|------|---------|-------|------------|

|       |        |    |      |
|-------|--------|----|------|
| 2BL-1 | 40x57  | 1  | 4700 |
| 2LG-1 | 40x114 | 17 | 4700 |
| 2TL-1 | 40x114 | 1  | 5100 |

### Wall B



| Mark | Profile | Count | Cut Length |
|------|---------|-------|------------|
|------|---------|-------|------------|

|        |        |    |      |
|--------|--------|----|------|
| BLG-1* | 40x114 | 1  | 915  |
| BLG-2* | 40x114 | 1  | 2536 |
| BLG-3  | 40x114 | 18 | 3500 |
| BLG-4* | 40x114 | 1  | 3500 |

\* Gable - delivered premounted

### Log Profiles

| Profile | Profile |
|---------|---------|
|---------|---------|

|        |   |
|--------|---|
| 40x57  |  |
| 40x114 |  |

### Log Profiles

| Profile | Profile |
|---------|---------|
|---------|---------|

|        |   |
|--------|---|
| 40x114 |  |
|--------|---|

# Windboard

① Windboard Assembly 1



② Windboard Assembly 2

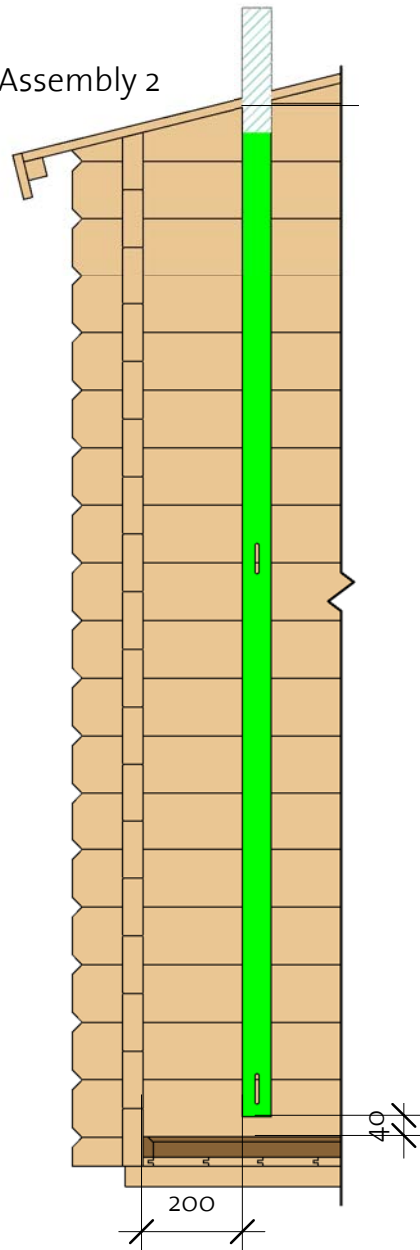

③ Windboard Assembly 3

